

8 7 6 5 4 3 2 1

F  
E  
D  
C  
B  
A

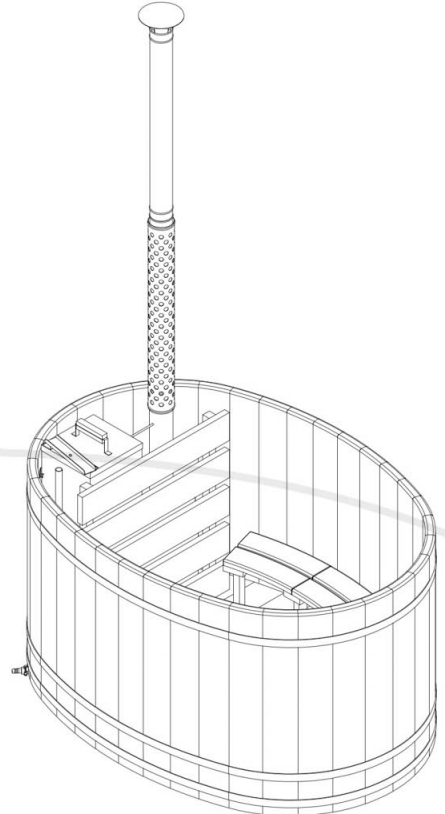
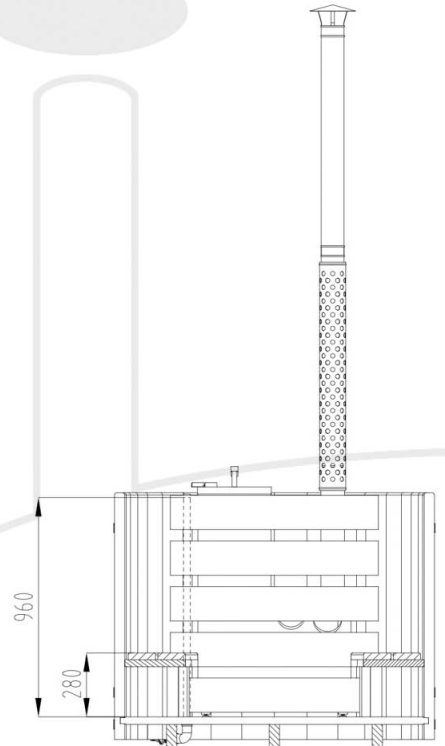
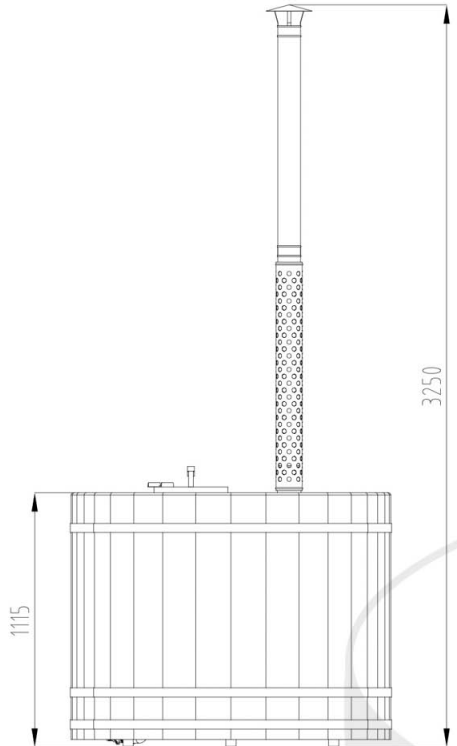

Wasser Volumen	1'560 Liter (bei 85cm Füllhöhe)
Leergewicht	390 kg
Hinweise: Technische Änderungen Vorbehalten	

SCHNITT A-A

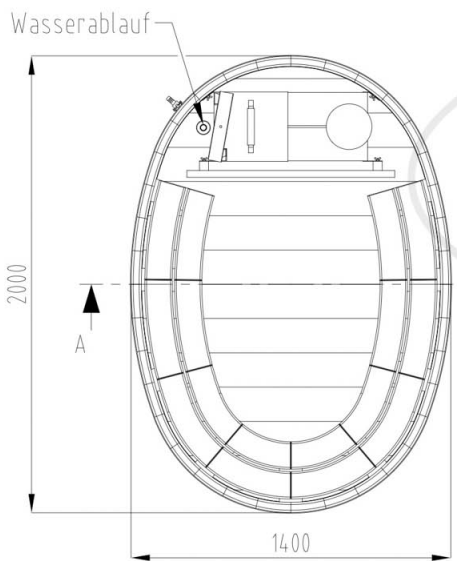

ANSICHT VON OBEN

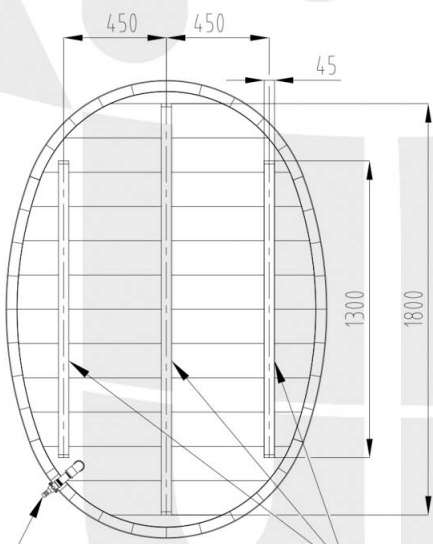

ANSICHT VON UNTEN

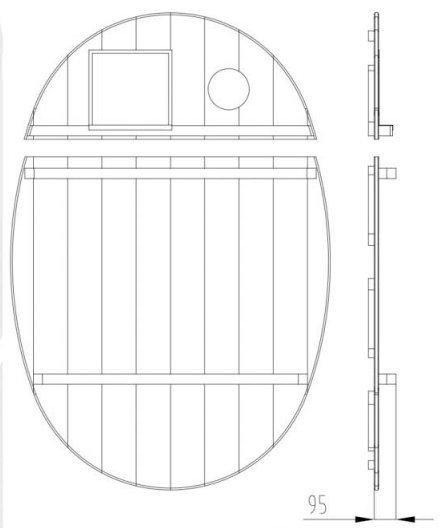

ABDECKUNGEN ALS ZUBEHÖR

NAME	BUCH	DATUM	20.09.2023
GEZEICHNET	AND	GEPRÜFT	20.09.2023
 tünni.ch GmbH Hotpot & Wellness			

BENENNUNG:	<b>TÜNNI OVAL 5</b>		
ZEICHNUNGS-NR.	T0-5-02	 A3	
MASSSTAB:	1:25	BLATT: 1/1	

8 7 6 5 4 3 2 1