

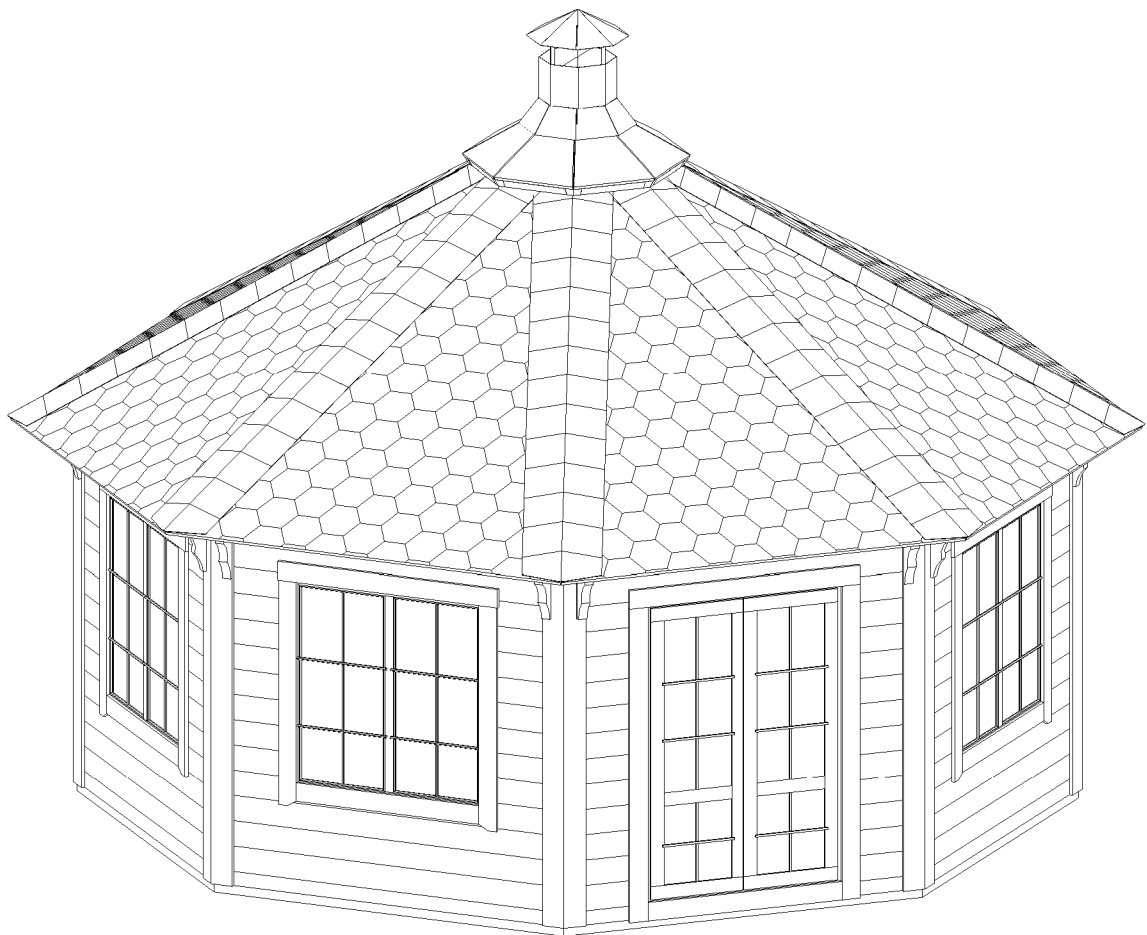









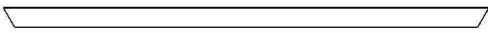











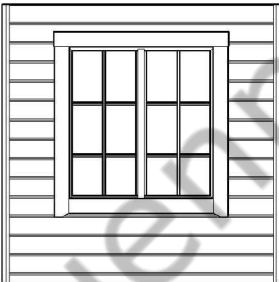

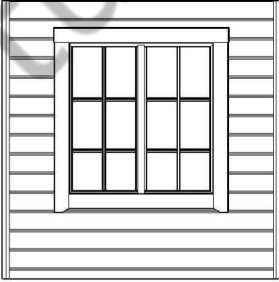
# Montageanleitung Pavillon 14.9m<sup>2</sup>







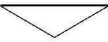





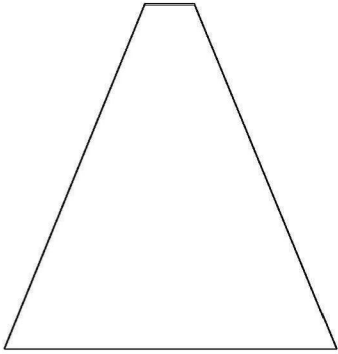

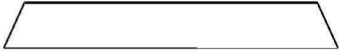



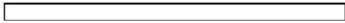

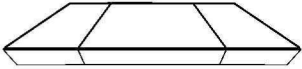
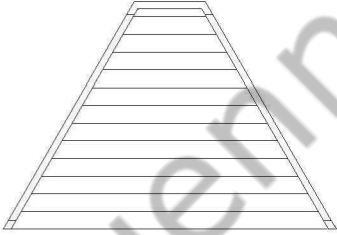

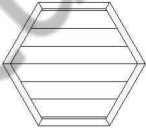



WICHTIG, BEACHTEN SIE DIE FUNDAMENT HINWEISE AUF:

[tuenni.ch/\\_fundament-planung](http://tuenni.ch/_fundament-planung)

## Pavillon 14.9m2

Nr.	Detail		Stück	
1			8	
2			1	
2.1			2	
2.2			4	
2.3			1	
2.4			1	
3			3	
4			4	
5			16	
5.1			16	
6			8	
7			8	

## Pavillon 14.9m2

Nr.	Detail		Stück	
8			8	
9			8	
10			8	
11			8	
12			1	
13			8	
14			1	
15			8	
16			8	
17			8	
18			7	SL
19			2	ASL
20			21	



# 1. Pavillon 14.9m2

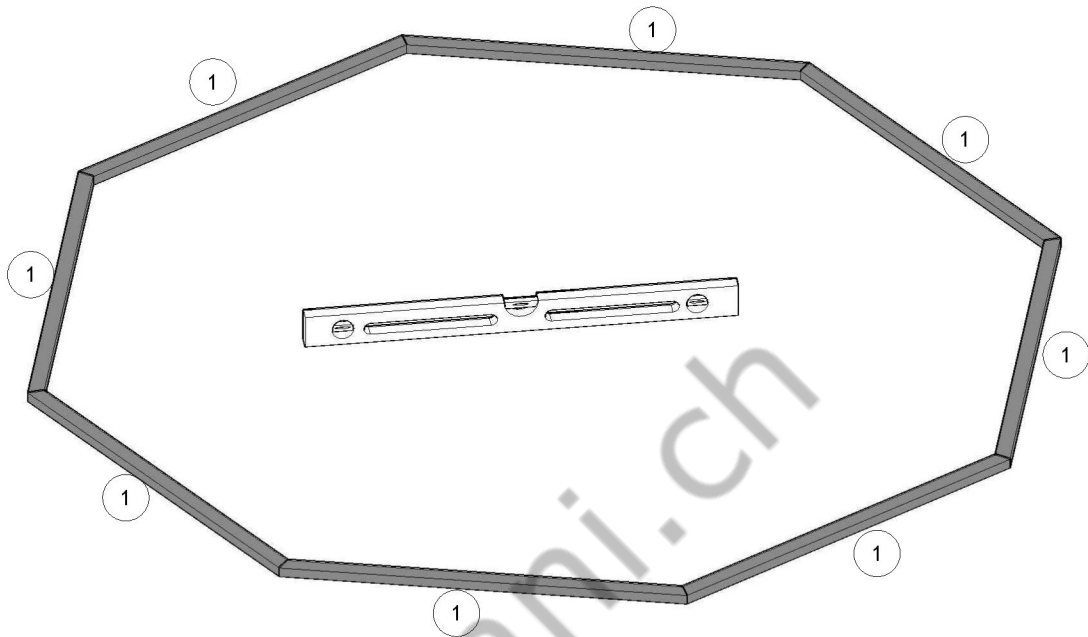

**1**

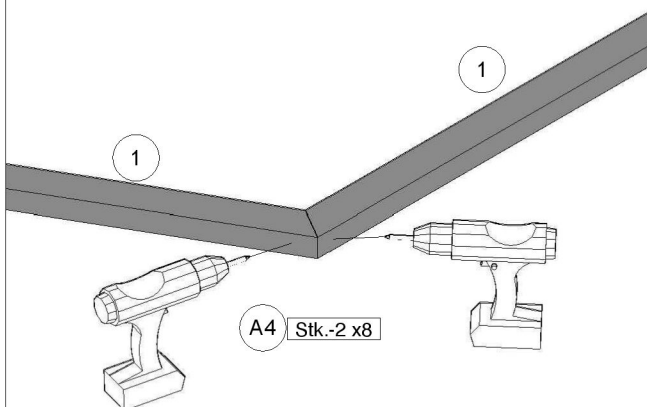

**2**

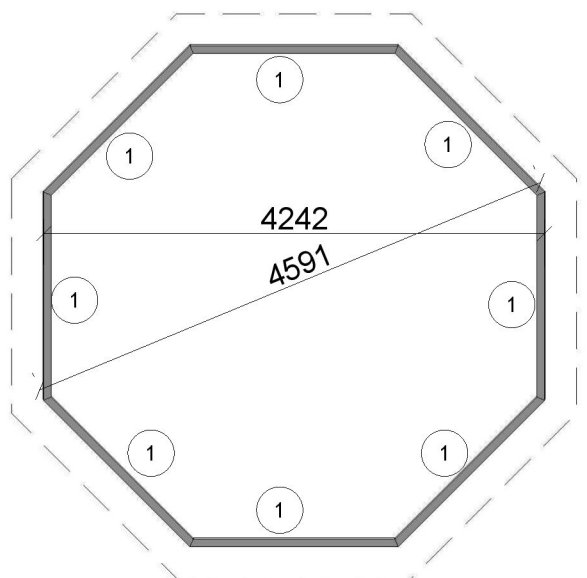

## 2. Pavillon 14.9m<sup>2</sup>

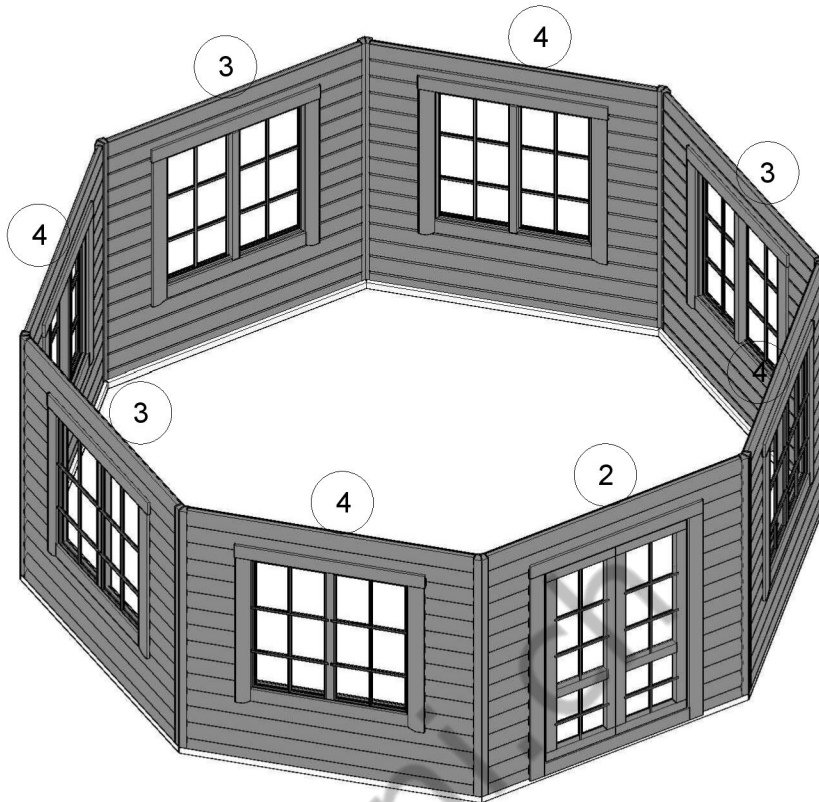

1

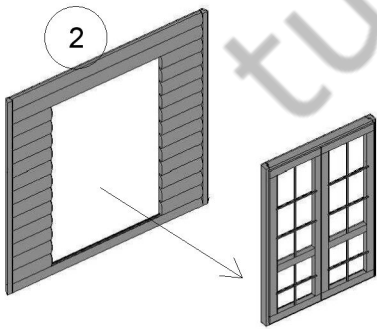

3

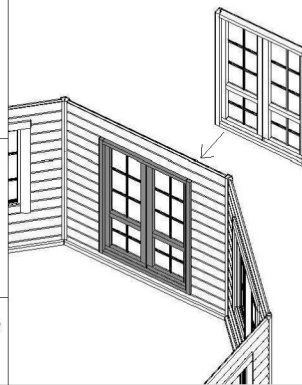

4

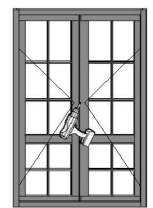

A3 Stk. -4

2

A5 Stk. - 8 x 8

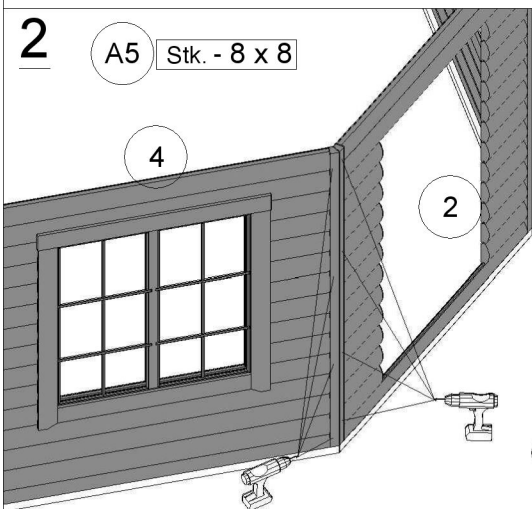

5

A6 Stk. -20x2

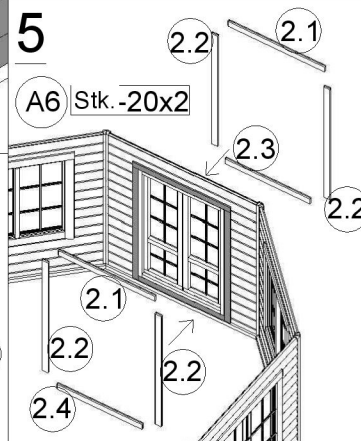

6

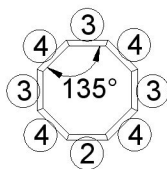
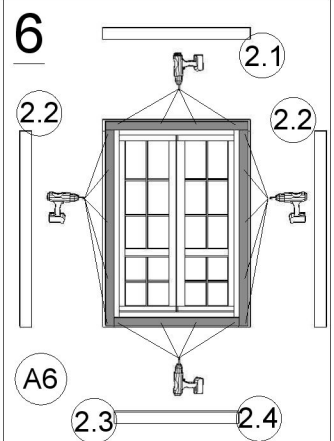

### 3. Pavillon 14.9m2

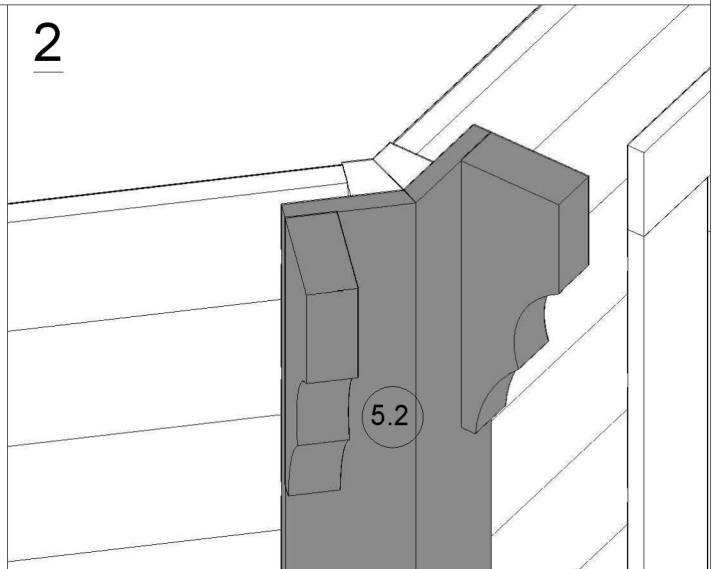
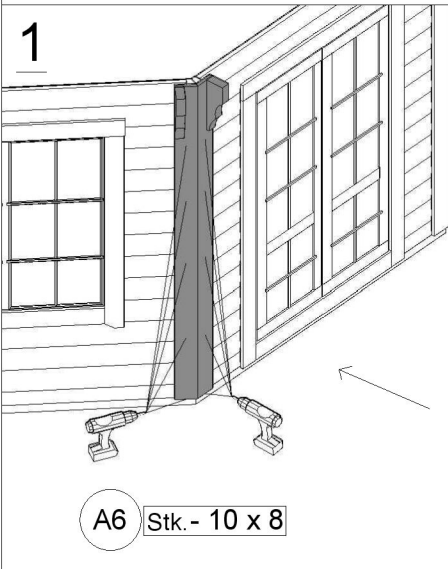
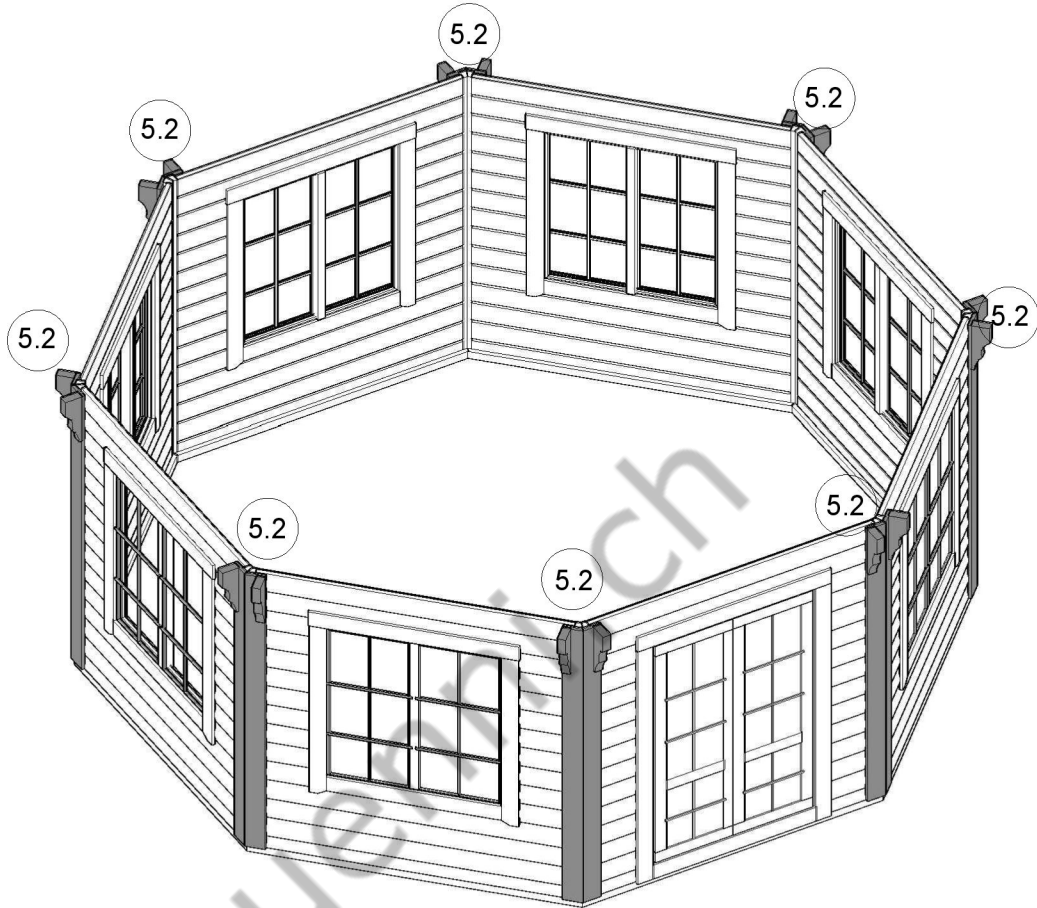

### 3.1 Pavillon 14.9m2

#### Zierleiste Aussen

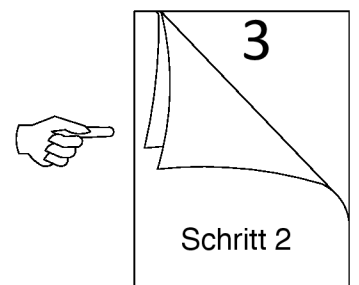
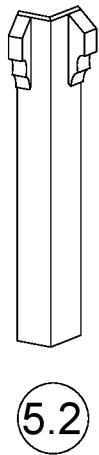
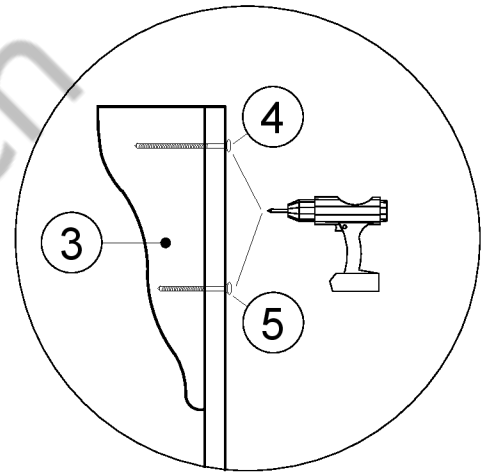
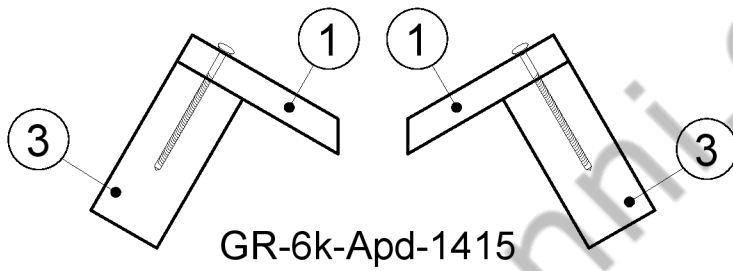
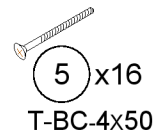
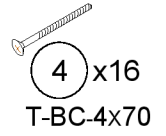
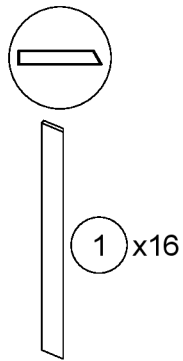



# 4. Pavillon 14.9m2

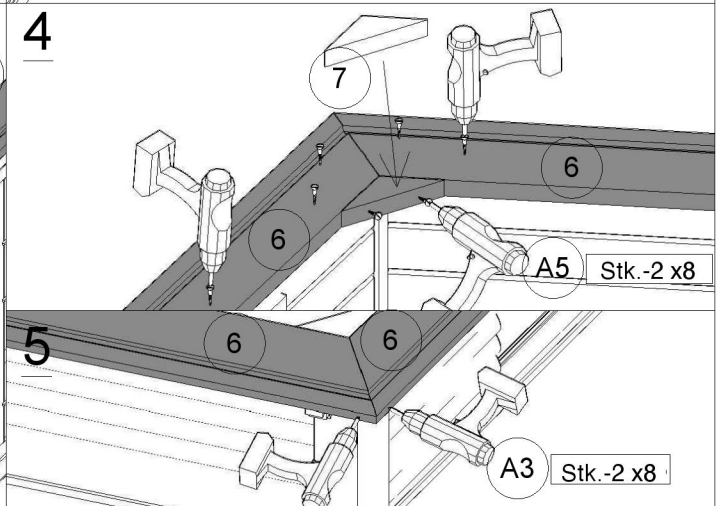
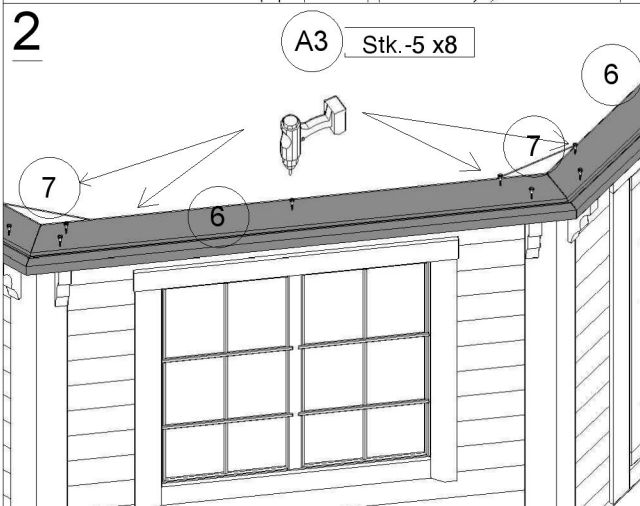
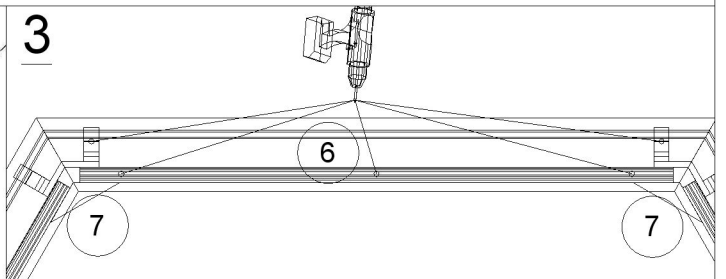
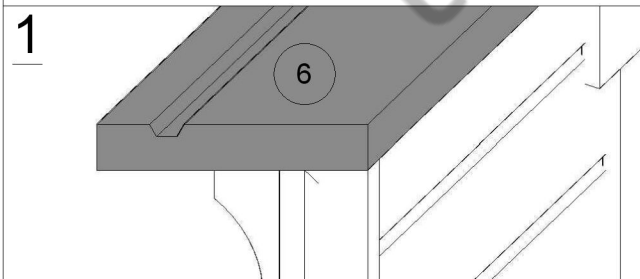
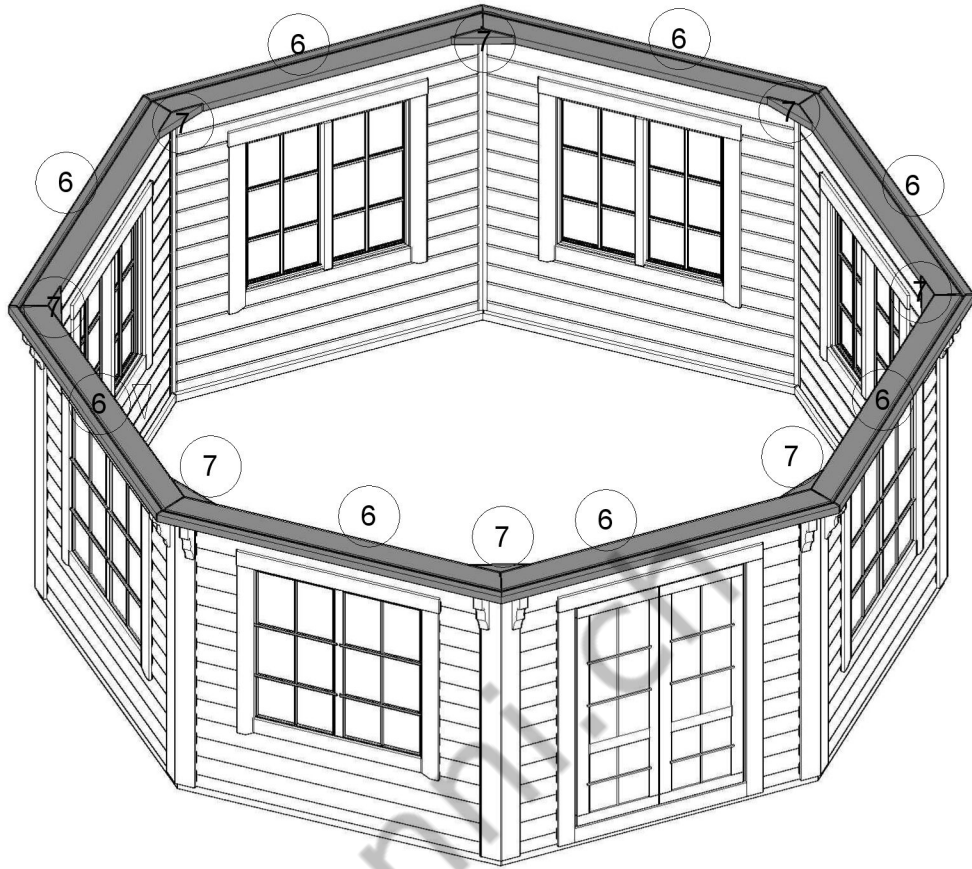

# 5. Pavillon 14.9m2

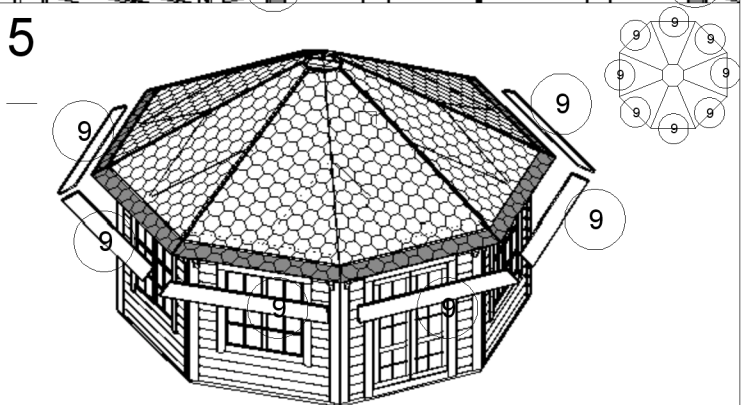
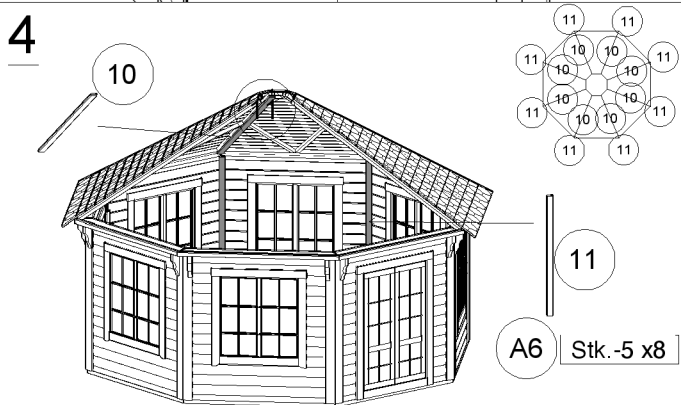
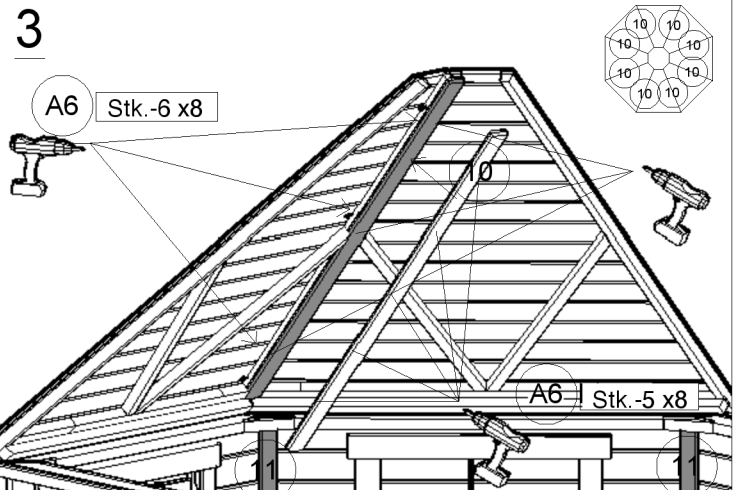
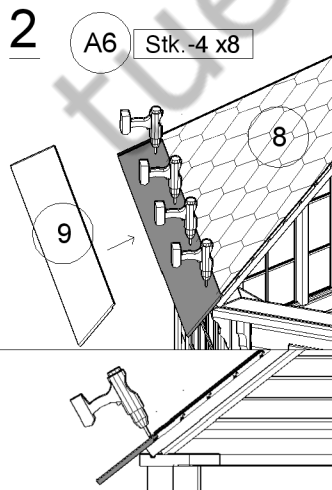
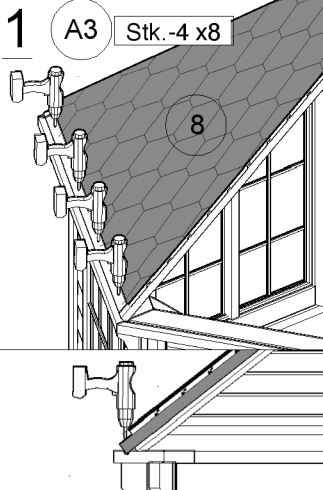
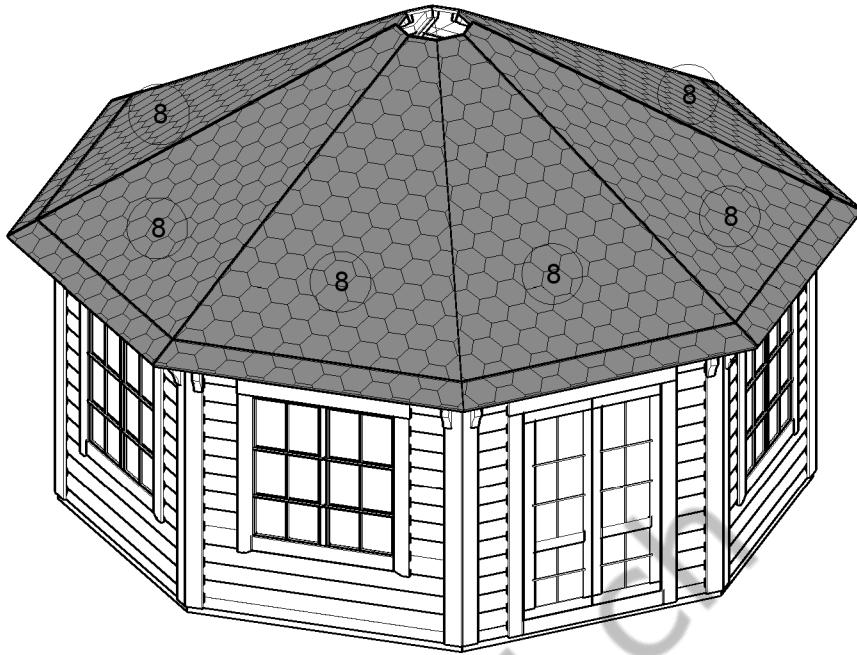

# 6. Pavillon 14.9m2

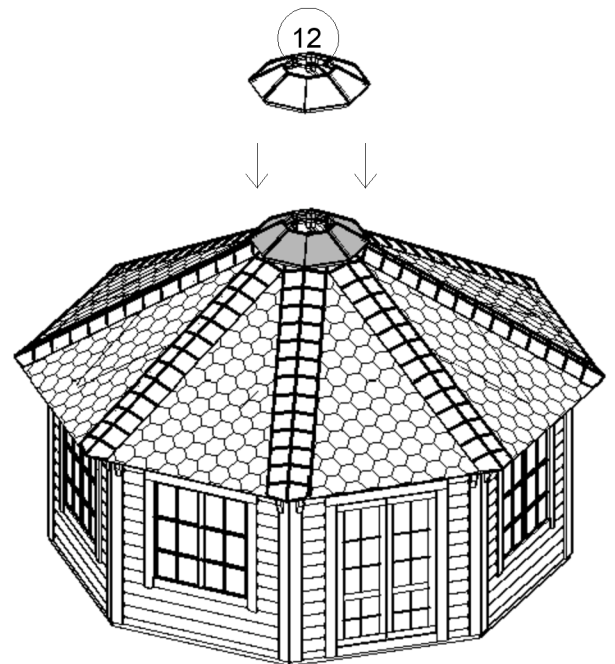
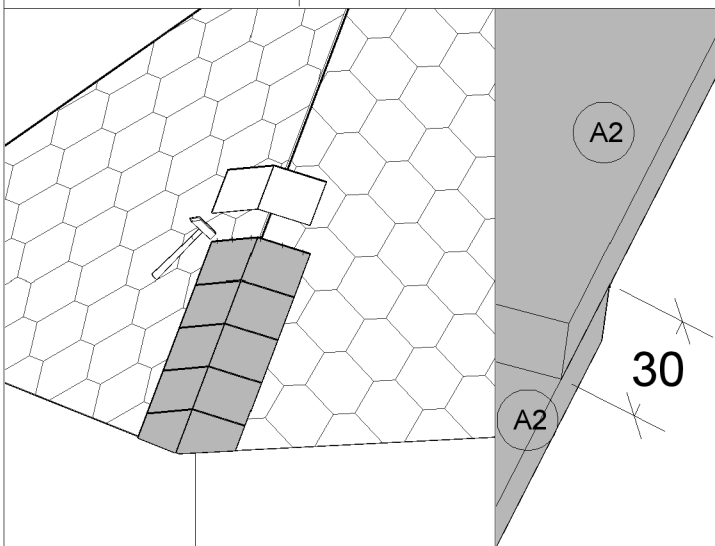
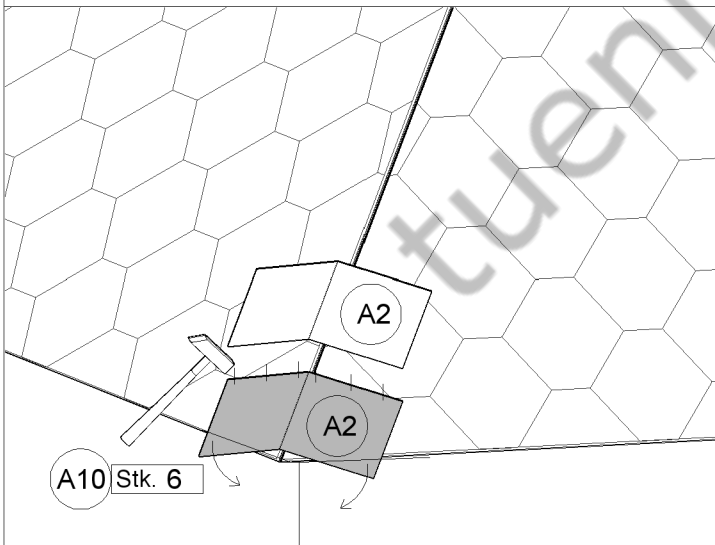
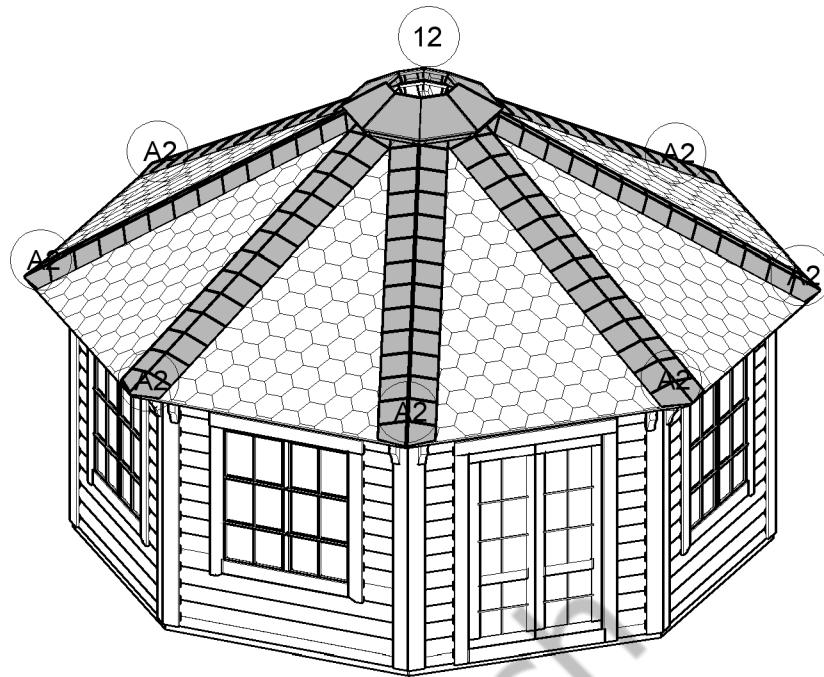

# 7. Pavillon 14.9m2

Bodenelemente

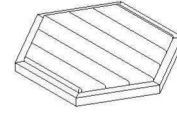
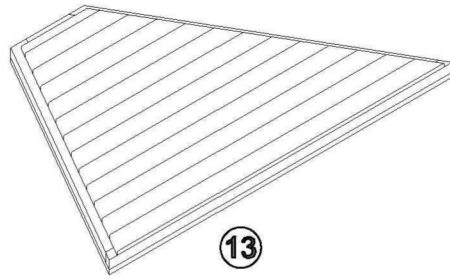
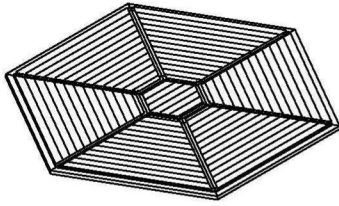

**A11** x42  
T-GC-3.5x45

1. Schritt:

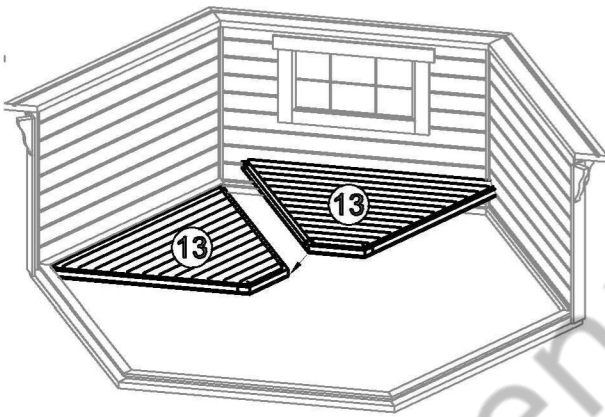

2. Schritt:

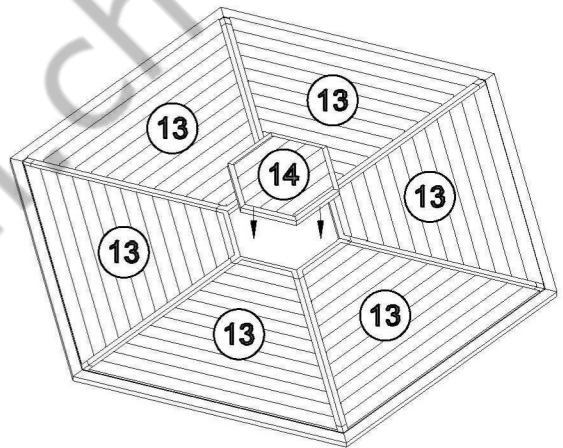

3. Schritt:

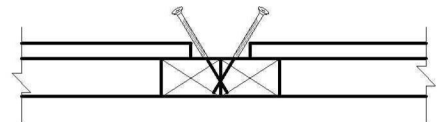
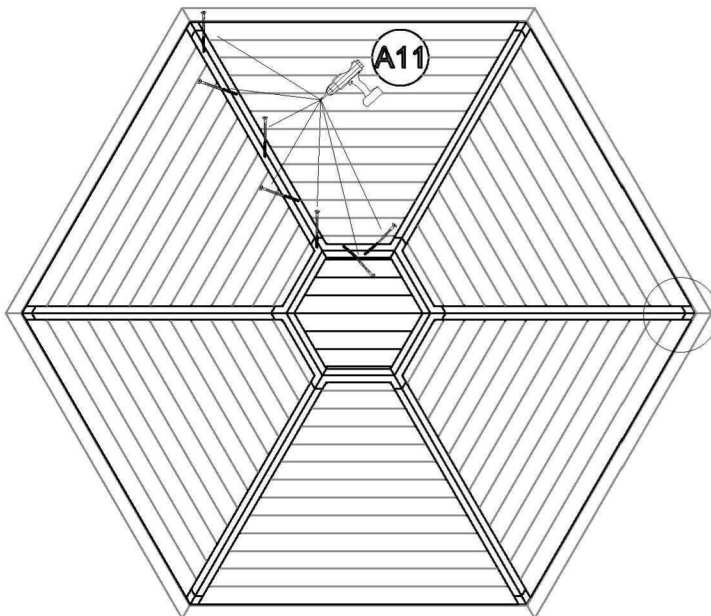

# 8. Pavillon 14.9m<sup>2</sup> Boden-Verbindungselemente

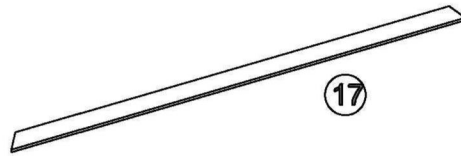
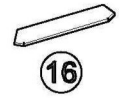
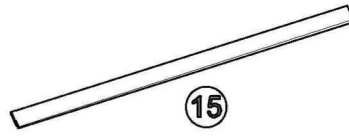
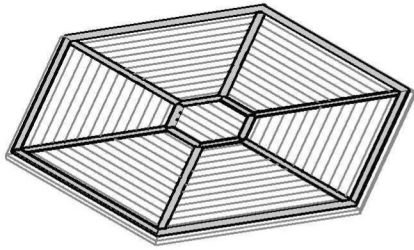

1. Schritt:

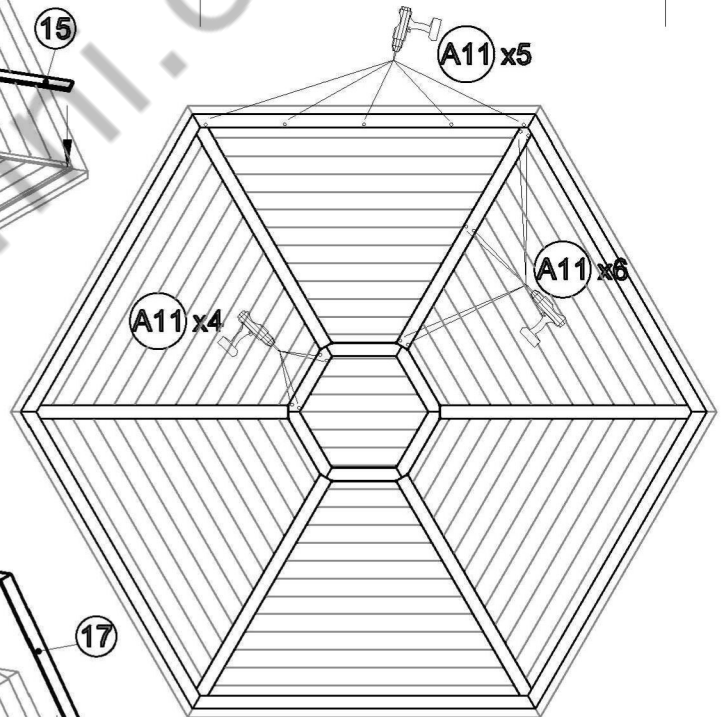
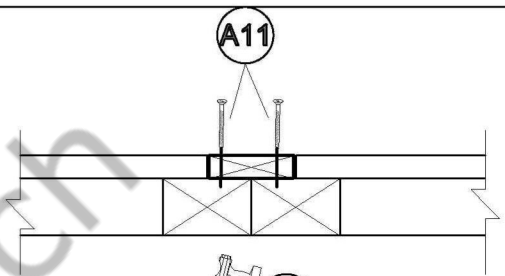
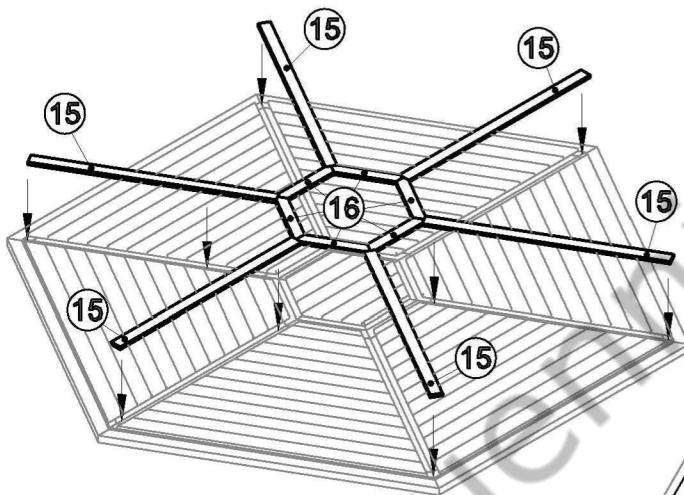

2. Schritt:

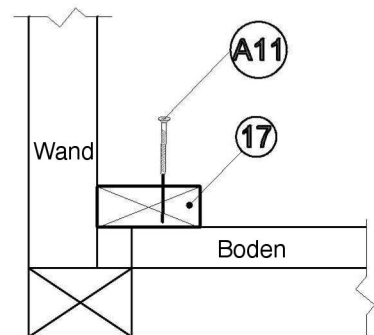
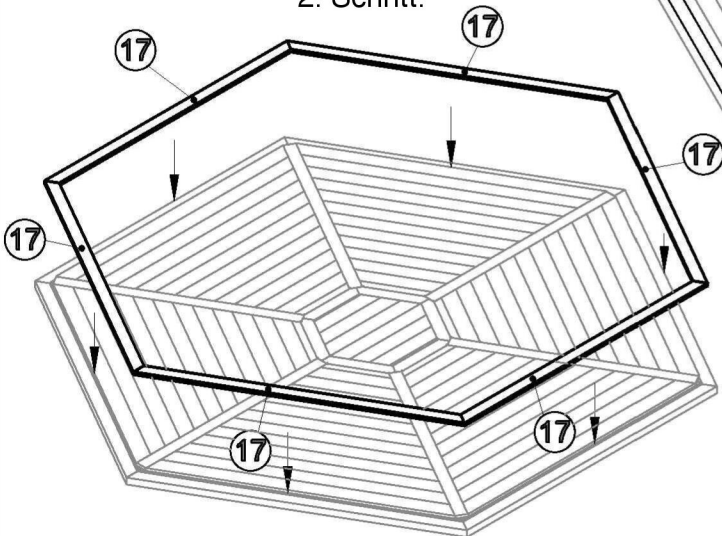

9. Pavillon 14.9m<sup>2</sup>  
Sitzbänke

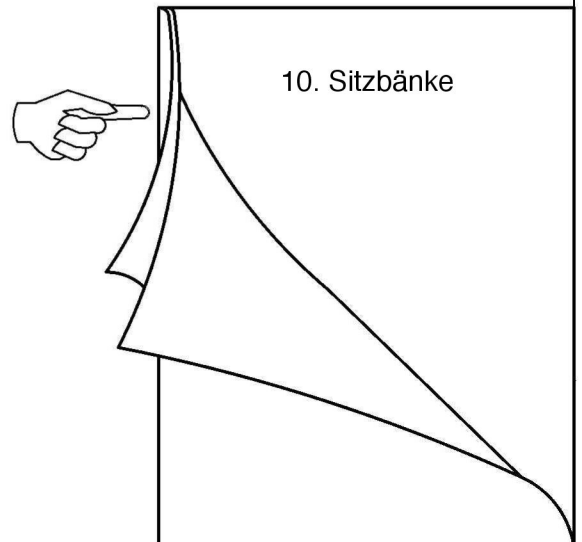
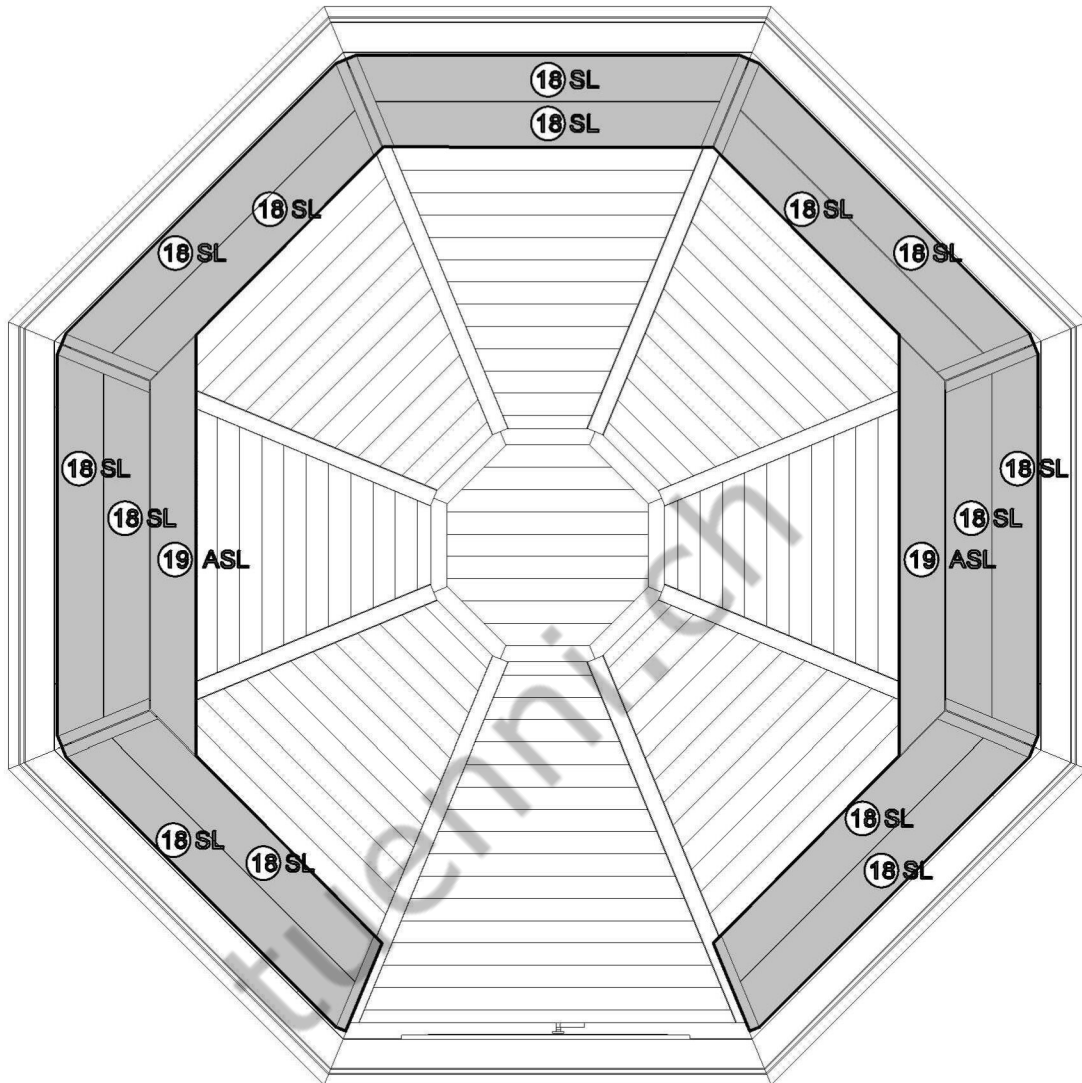

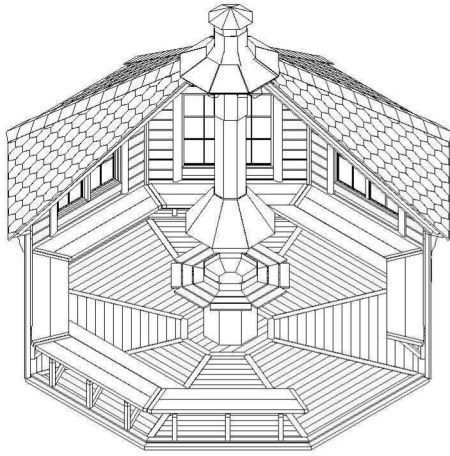

## 10. Pavillon 14.9m<sup>2</sup> Sitzbänke

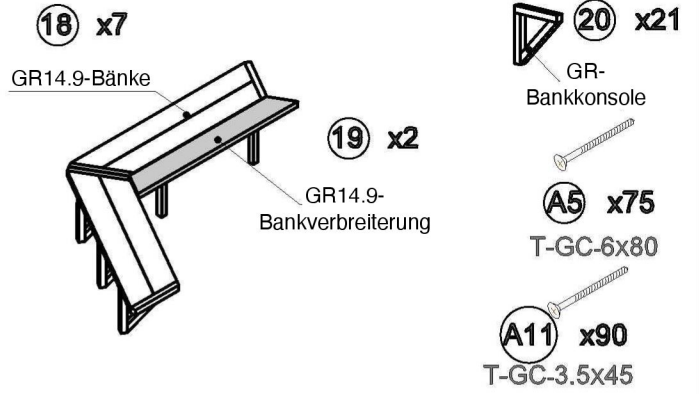

1. Schritt:

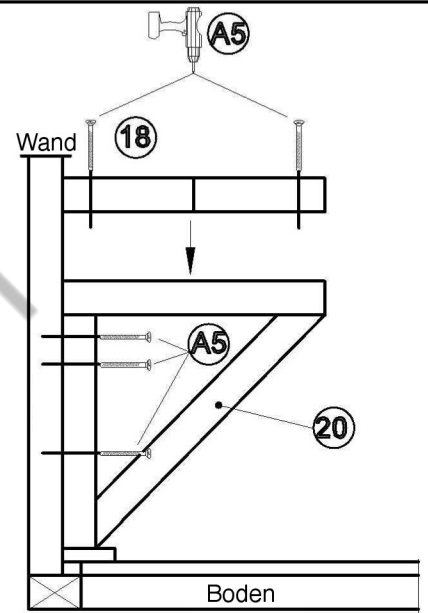
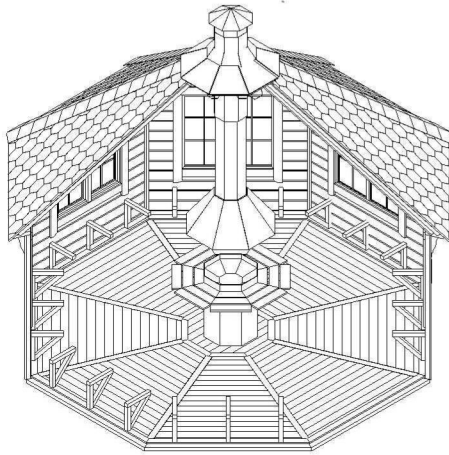

2. Schritt:

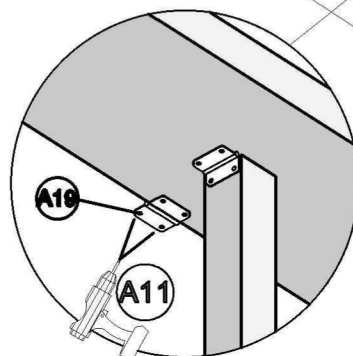
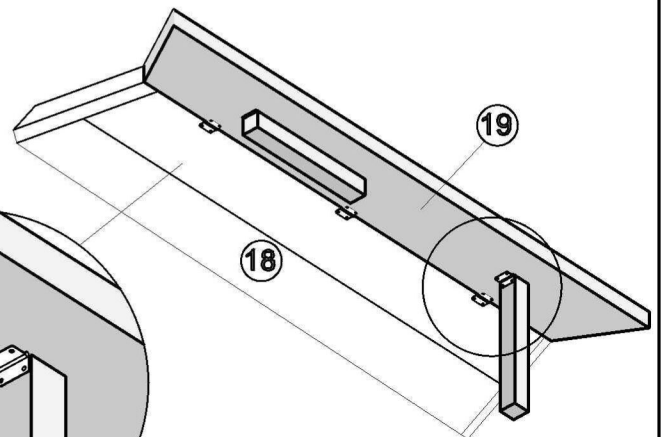
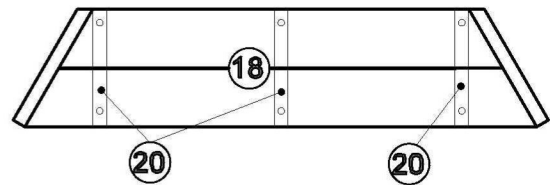
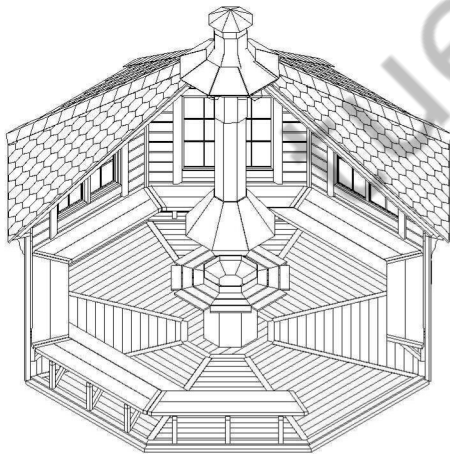

# 11. Pavillon 14.9m2

