

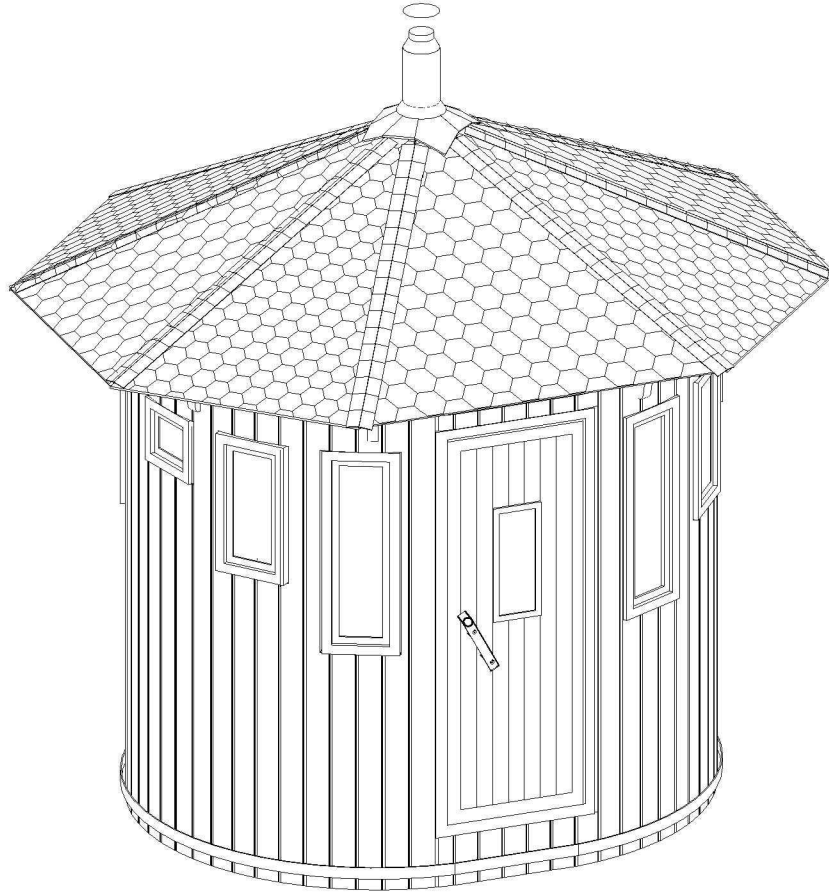











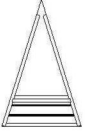
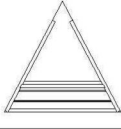
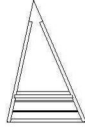
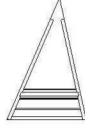

# Montageanleitung Vertical



WICHTIG, BEACHTEN SIE DIE FUNDAMENT HINWEISE AUF:

[tuenni.ch/vertical\\_fundament-planung](https://tuenni.ch/vertical_fundament-planung)

## Vertical

Nr.		Detail	Stück	Dimensionen	
1			2	1067 x 1703 x 63	
2			2	1567 x 1492 x 63	
3			2	1068 x 1641 x 63	
4			2	1068 x 1641 x 63	
5			8	300 x 100 x 45	
6			6	195 x 865 x 45	
7			2	195 x 1265 x 45	
8			1	500 x 500 x 1	
9			1	500 x 500 x 1	
10			1	120 x $\varnothing$ 250	
11			1	1000 x $\varnothing$ 120	
12			2	700 x $\varnothing$ 200	
13			1	_____	
14			1	_____	
15			2	_____	



# 1. Vertical

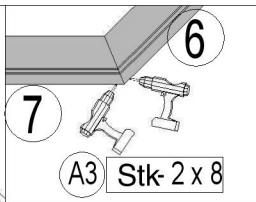
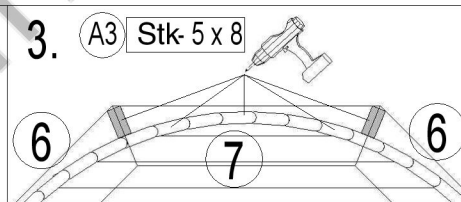
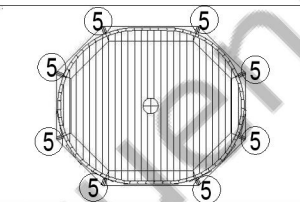
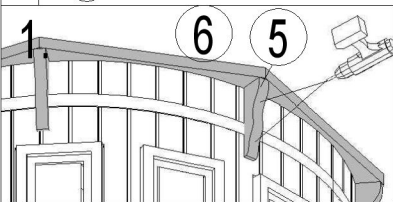
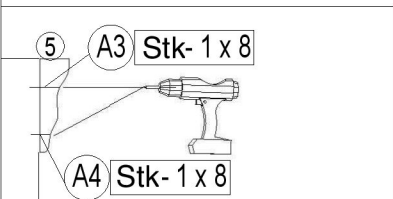
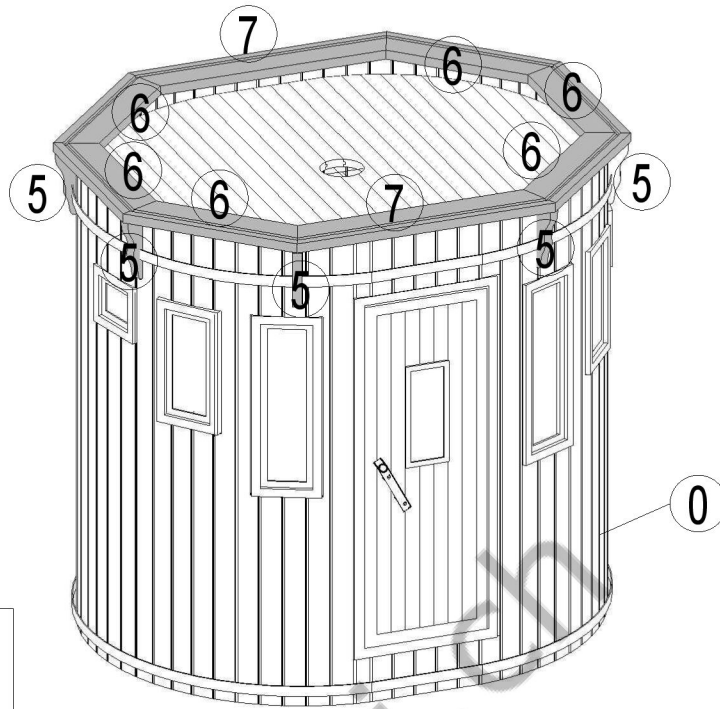

2.

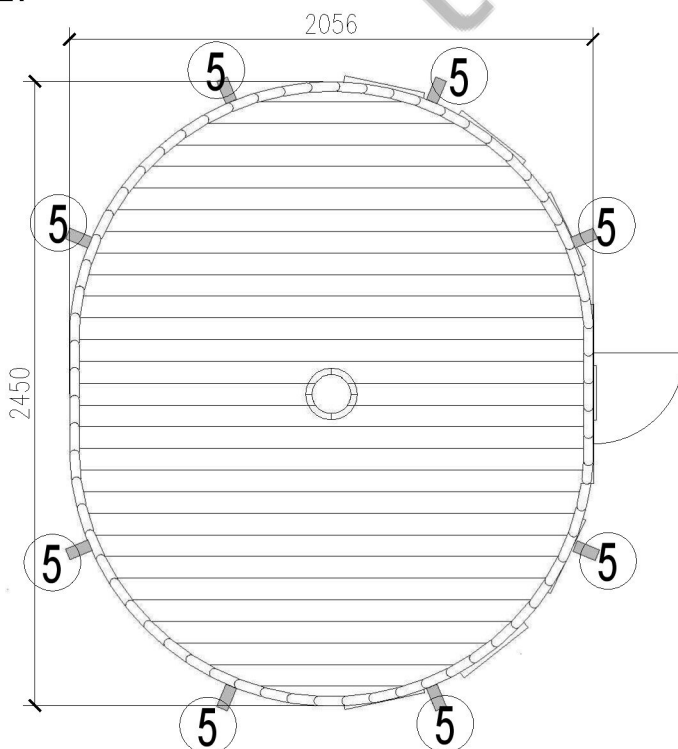

4.

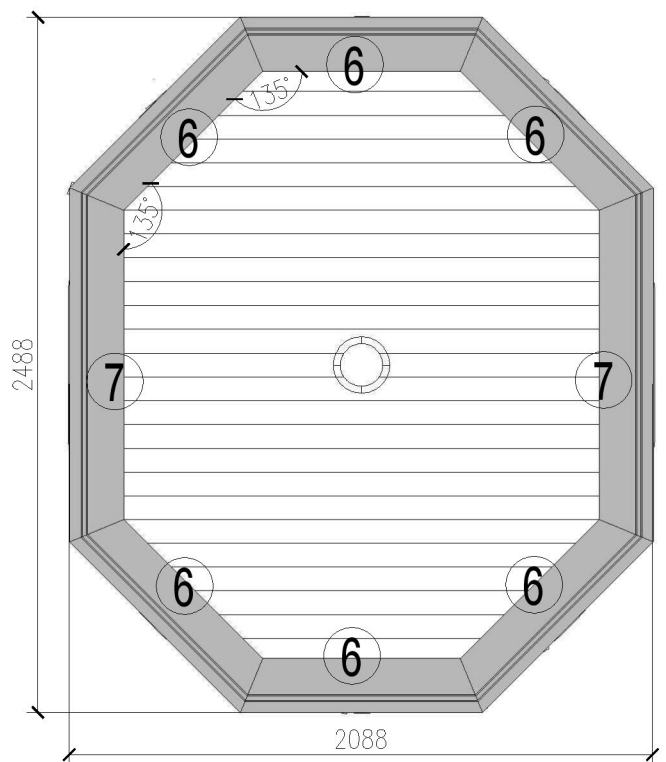

## 2. Vertical

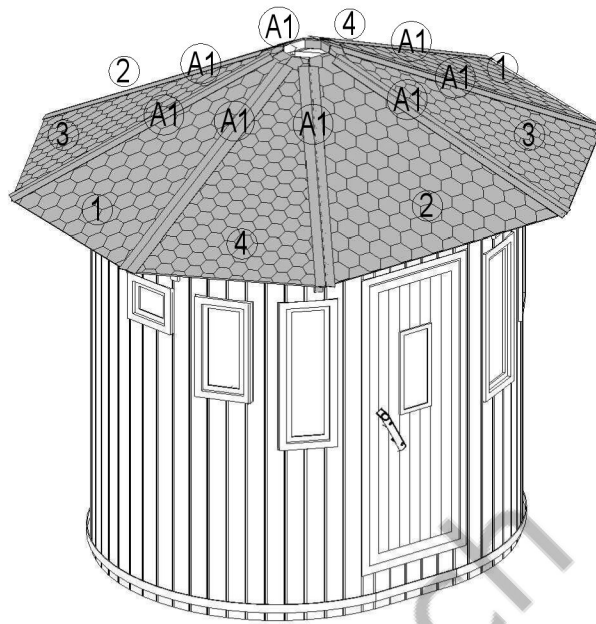

1

A3 Stk-6 x 6

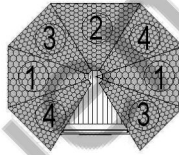
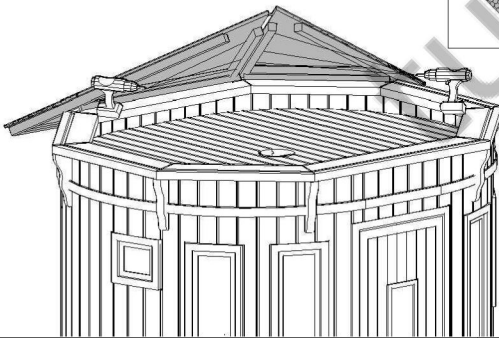

3

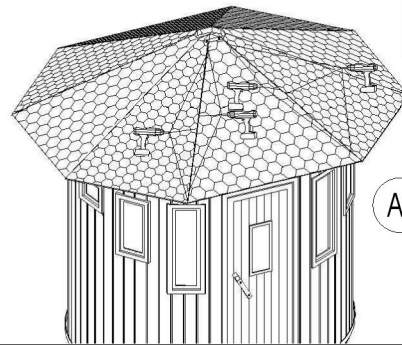
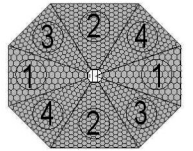

A3 Stk-6 x 2

2

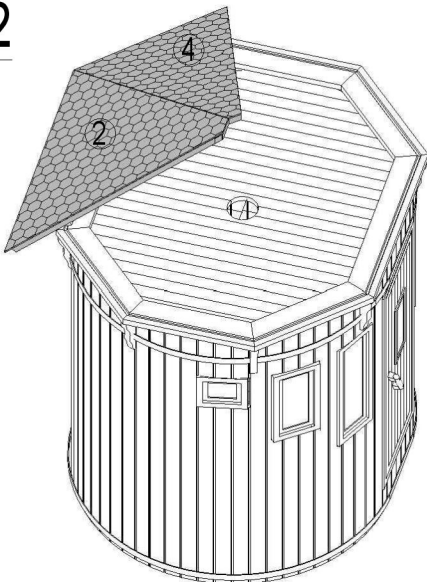

4

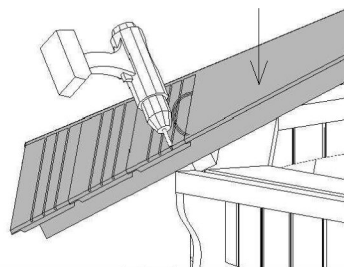

5

A3 Stk-4 x 8

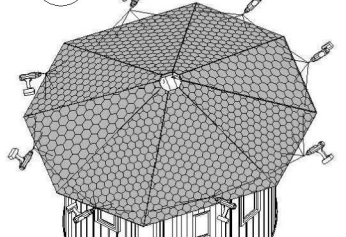

6

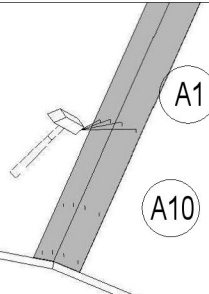

A1

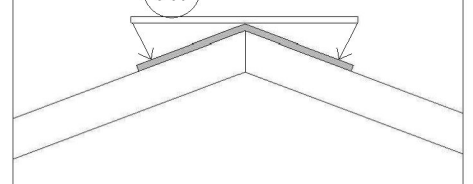

# Vertical Dachplan

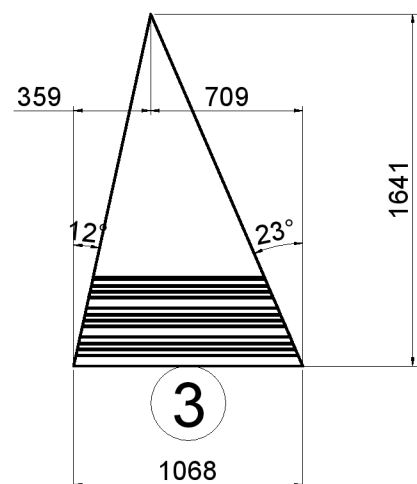
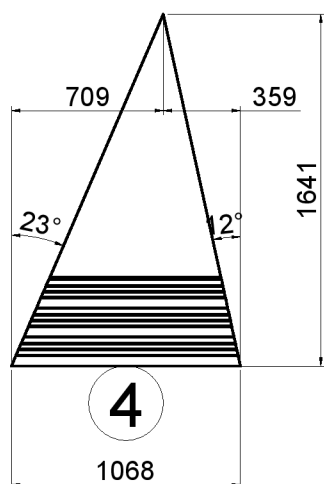
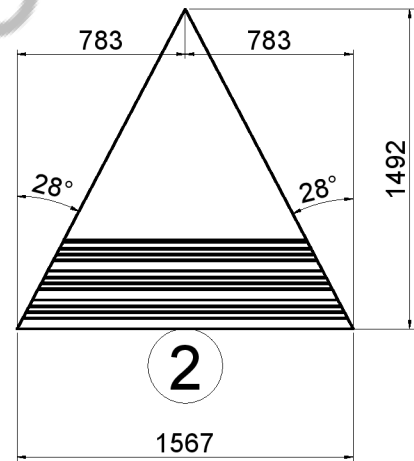
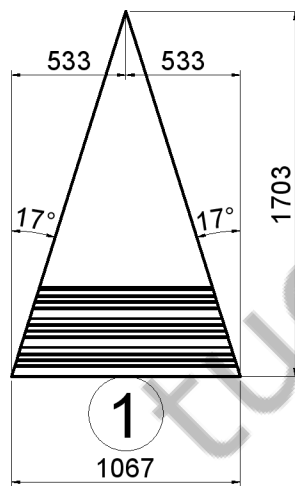
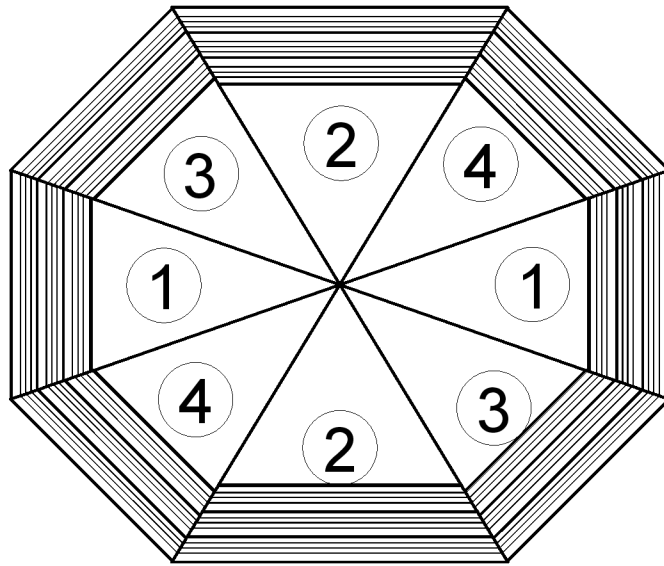

### 3. Vertical

